

SPEC

| | |
|----------|-----------------------|
| Spec No. | TQ3C-8EAF0-E1DEU14-01 |
| Date | Aug 11,2009 |

TYPE : TCG057VG1CE-H50
< 5.7 inch VGA transmissive color TFT
with touch panel >

CONTENTS

1. Application
2. Construction and outline
3. Mechanical specifications
4. Absolute maximum ratings
5. Electrical characteristics
6. Optical characteristics
7. Interface signals
8. Input timing characteristics
9. Backlight characteristics
10. Design guidance for analog touch panel
11. Lot number identification
12. Warranty
13. Precautions for use
14. Reliability test data
15. Outline drawing

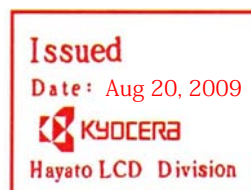

KYOCERA CORPORATION
KAGOSHIMA HAYATO PLANT
LCD DIVISION

This specification is subject to change without notice.
Consult Kyocera before ordering.

| Original Issue Date | Designed by: Engineering dept. | | | Confirmed by: QA dept. | |
|---------------------|--------------------------------|-------------|--------------|------------------------|----------|
| | Prepared | Checked | Approved | Checked | Approved |
| May 15, 2009 | Y IKEDA | H.Tokumichi | Y. Matsumoto | J. Sakaguchi | To. Sak |

| | | |
|-----------------------------------|-----------------------------|-----------|
| Spec No. TQ3C-8EAF0-E1DEU14-01 | Part No. TCG057VG1CE-H50 | Page - |
|-----------------------------------|-----------------------------|-----------|

Warning

1. This Kyocera LCD module has been specifically designed for use only in electronic devices and industrial machines in the area of audio control, office automation, industrial control, home appliances, etc. The module should not be used in applications where the highest level of safety and reliability are required and module failure or malfunction of such module results in physical harm or loss of life, as well as enormous damage or loss. Such fields of applications include, without limitation, medical, aerospace, communications infrastructure, atomic energy control. Kyocera expressly disclaims any and all liability resulting in any way to the use of the module in such applications.

2. Customer agrees to indemnify, defend and hold Kyocera harmless from and against any and all actions, claims, damages, liabilities, awards, costs, and expenses, including legal expenses, resulting from or arising out of Customer's use, or sale for use, or Kyocera modules in applications.

Caution

1. Kyocera shall have the right, which Customer hereby acknowledges, to immediately scrap or destroy tooling for Kyocera modules for which no Purchase Orders have been received from the Customer in a two-year period.

| | | |
|-----------------------------------|-----------------------------|-----------|
| Spec No. TQ3C-8EAF0-E1DEU14-01 | Part No. TCG057VG1CE-H50 | Page - |
|-----------------------------------|-----------------------------|-----------|

Revision record

| Date | | Designed by : Engineering dept. | | | Confirmed by : QA dept. | |
|-------------|-------------|---------------------------------|--|--------------|-------------------------|----------|
| | | Prepared | Checked | Approved | Checked | Approved |
| Aug 11,2009 | | Y IKEDA | H.Tokumaru | G. MATSUMOTO | J. Sakaguchi | To. Itoh |
| Rev.No. | Date | Page | Descriptions | | | |
| 01 | Aug 11,2009 | 3 | 5.Electrical characteristics ~Change "Current consumption" ~Change "Display pattern" | | | |
| | | | | | | |

1. Application

This document defines the specification of TCG057VG1CE-H50. (RoHS Compliant)

2. Construction and outline

| | |
|----------------------|---|
| LCD | : Transmissive color dot matrix type TFT |
| Backlight system | : CFL (1 tube, U-figure type) |
| Inverter | : Option |
| Recommended inverter | : CXA-L0612A-VJL (TDK) or equivalent |
| Polarizer | : Glare low-reflection treatment |
| Additional circuit | : Timing controller, Power supply (3.3V input) |
| Touch panel | : Analog type(Glass/Glass), Glare Anti-reflection treatment |

3. Mechanical specifications

3-1. LCD

| Item | Specification | Unit |
|-----------------------|---|------|
| Outline dimensions 1) | 144(W)×(104.8)(H)×14.5(D) | mm |
| Active area | 115.2(W)×86.4(H) (14.4cm/5.7 inch(Diagonal)) | mm |
| Dot format | 640×(B,G,R)(W)×480(H) | dot |
| Dot pitch | 0.06(W)×0.18(H) | mm |
| Base color 2) | Normally White | - |
| Mass | 250 | g |

1) Projection not included. Please refer to outline for details.

2) Due to the characteristics of the LCD material, the color varies with environmental temperature.

3-2. Touch panel

| Item | Specification | Unit |
|------------------|--------------------------------------|------|
| Input | Radius-0.8 stylus or Finger | - |
| Actuation Force | 0.1~2.0 | N |
| Transmittance | Typ. 85 | % |
| Surface hardness | Pencil hardness 2H or more according | - |

4. Absolute maximum ratings

4-1. Electrical absolute maximum ratings

| Item | Symbol | Min. | Max. | Unit |
|--------------------------------|-----------------|------|------|------|
| Supply voltage for logic | V _{DD} | 0 | 4.0 | V |
| Input signal voltage 1) | V _{IN} | -0.3 | 6.0 | V |
| Supply voltage for touch panel | V _{TP} | 0 | 6.0 | V |
| Input current of touch panel | I _{TP} | 0 | 0.5 | mA |

1) Input signal : CK, R0~R5, G0~G5, B0~B5, H_{SYNC}, V_{SYNC}, ENAB, R/L, U/D

4-2. Environmental absolute maximum ratings

| Item | Symbol | Min. | Max. | Unit |
|--------------------------|------------------|------|------|------|
| Operating temperature 1) | T _{OP} | -10 | 70 | °C |
| Storage temperature 2) | T _{STO} | -30 | 80 | °C |
| Operating humidity 3) | H _{OP} | 10 | 4) | %RH |
| Storage humidity 3) | H _{STO} | 10 | 4) | %RH |
| Vibration | - | 5) | 5) | - |
| Shock | - | 6) | 6) | - |

1) Operating temperature means a temperature which operation shall be guaranteed. Since display performance is evaluated at 25°C, another temperature range should be confirmed.

2) Temp. = -30°C < 48h , Temp. = 80°C < 168h

Store LCD at normal temperature/humidity. Keep them free from vibration and shock.

An LCD that is kept at a low or a high temperature for a long time can be defective due to other conditions, even if the low or high temperature satisfies the standard.

(Please refer to "Precautions for Use" for details.)

3) Non-condensing

4) Temp. ≤ 40°C, 85%RH Max.

Temp. > 40°C, Absolute humidity shall be less than 85%RH at 40°C.

5)

| | | |
|-----------------|-------------|---|
| Frequency | 10~55 Hz | Acceleration value (0.3~9 m/s ²) |
| Vibration width | 0.15mm | |
| Interval | 10-55-10 Hz | 1 minutes |

2 hours in each direction X, Y, Z (6 hours total)

EIAJ ED-2531

6) Acceleration: 490 m/s², Pulse width: 11 ms

3 times in each direction: ±X, ±Y, ±Z

EIAJ ED-2531

6. Optical characteristics

Measuring spot = ϕ 6.0mm, Temp. = 25°C

| Item | Symbol | Condition | Min. | Typ. | Max. | Unit | |
|---|------------------|---------------------------|---------------------------|------|------|-------------------|----|
| Response time | Rise | τ_r | $\theta = \phi = 0^\circ$ | - | 10 | - | ms |
| | Down | τ_d | $\theta = \phi = 0^\circ$ | - | 25 | - | ms |
| Viewing angle range View direction : 12 o'clock (Gray inversion) | θ_{UPPER} | CR \geq 5 | - | 80 | - | deg. | |
| | θ_{LOWER} | | - | 80 | - | | |
| | ϕ_{LEFT} | | - | 80 | - | deg. | |
| | ϕ_{RIGHT} | | - | 80 | - | | |
| Contrast ratio | CR | $\theta = \phi = 0^\circ$ | 300 | 500 | - | - | |
| Brightness | L | IL=5.0mArms | 470 | 680 | - | cd/m ² | |
| Chromaticity coordinates | Red | x | $\theta = \phi = 0^\circ$ | 0.57 | 0.62 | 0.67 | - |
| | | y | | 0.30 | 0.35 | 0.40 | |
| | Green | x | $\theta = \phi = 0^\circ$ | 0.26 | 0.31 | 0.36 | |
| | | y | | 0.49 | 0.54 | 0.59 | |
| | Blue | x | $\theta = \phi = 0^\circ$ | 0.10 | 0.15 | 0.20 | |
| | | y | | 0.06 | 0.11 | 0.16 | |
| | White | x | $\theta = \phi = 0^\circ$ | 0.27 | 0.32 | 0.37 | |
| | | y | | 0.28 | 0.33 | 0.38 | |

6-1. Definition of contrast ratio

$$CR(\text{Contrast ratio}) = \frac{\text{Brightness with all pixels "White"}}{\text{Brightness with all pixels "Black"}}$$

6-2. Definition of response time

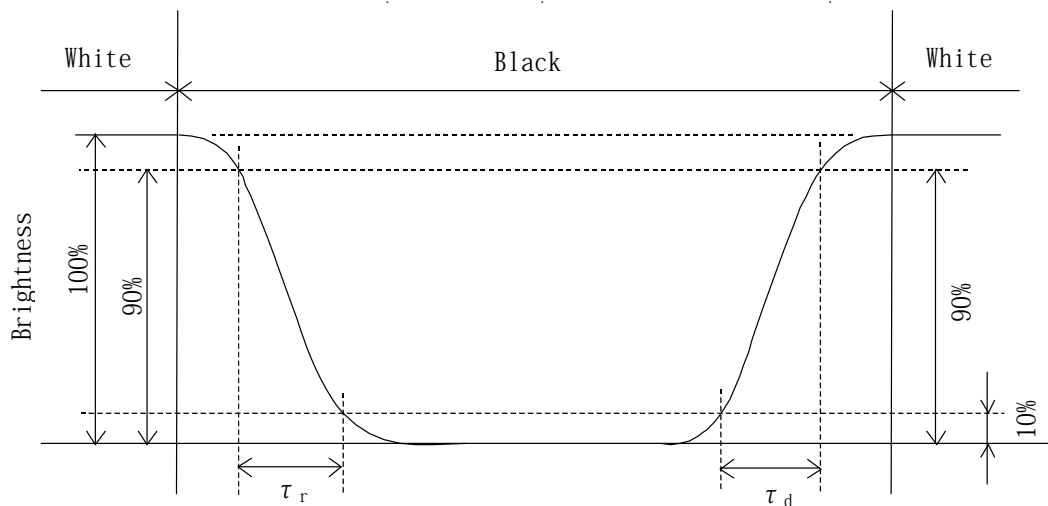

6-3. Definition of viewing angle

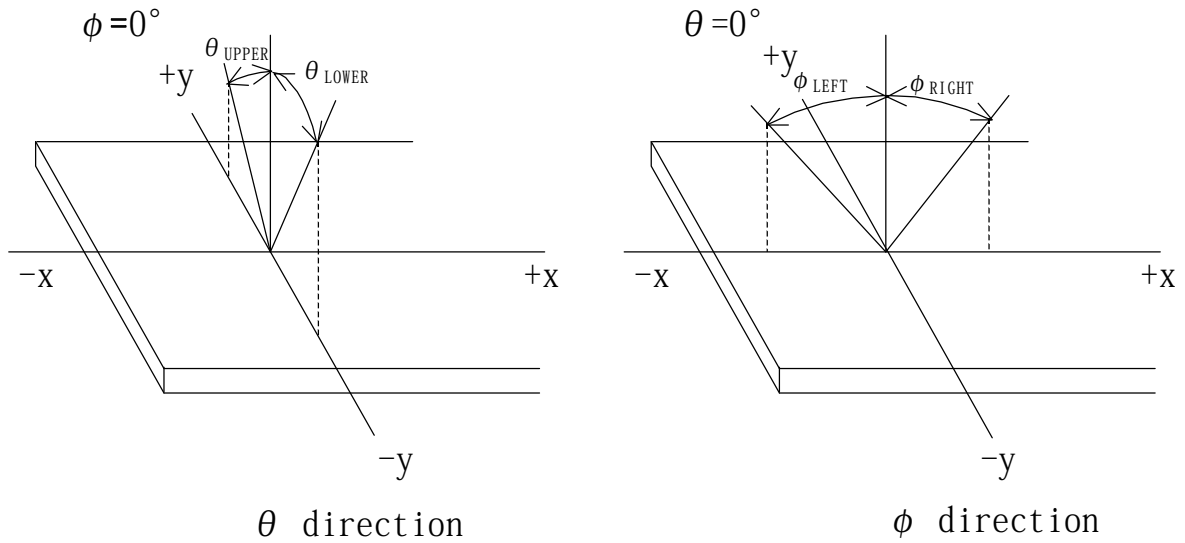

6-4. Brightness measuring points

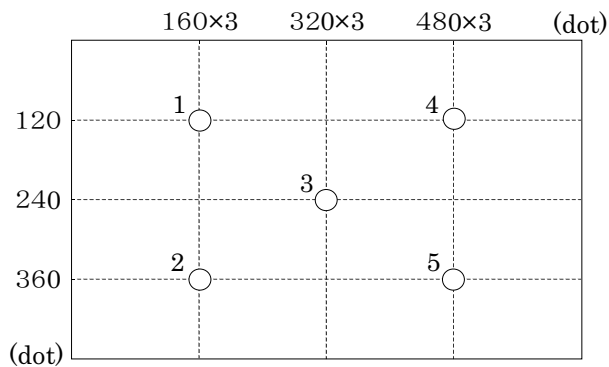

- 1) Rating is defined on the average in the viewing area. (measured point 1~5)
- 2) Measured 30 minutes after the CFL is powered on. (Ambient temp. = 25°C)
- 3) The inverter should meet the CFL rating in the specification:
 - Sine, symmetric waveform without spike in positive and negative.

7. Interface signals

7-1. LCD

| No. | Symbol | Description | I/O | Note |
|-----|-------------------|---|-----|------|
| 1 | GND | GND | - | |
| 2 | CK | Clock signal for sampling each data signal | I | |
| 3 | H _{SYNC} | Horizontal synchronous signal (negative) | I | |
| 4 | V _{SYNC} | Vertical synchronous signal (negative) | I | |
| 5 | GND | GND | - | |
| 6 | R0 | RED data signal (LSB) | I | |
| 7 | R1 | RED data signal | I | |
| 8 | R2 | RED data signal | I | |
| 9 | R3 | RED data signal | I | |
| 10 | R4 | RED data signal | I | |
| 11 | R5 | RED data signal (MSB) | I | |
| 12 | GND | GND | - | |
| 13 | G0 | GREEN data signal (LSB) | I | |
| 14 | G1 | GREEN data signal | I | |
| 15 | G2 | GREEN data signal | I | |
| 16 | G3 | GREEN data signal | I | |
| 17 | G4 | GREEN data signal | I | |
| 18 | G5 | GREEN data signal (MSB) | I | |
| 19 | GND | GND | - | |
| 20 | B0 | BLUE data signal (LSB) | I | |
| 21 | B1 | BLUE data signal | I | |
| 22 | B2 | BLUE data signal | I | |
| 23 | B3 | BLUE data signal | I | |
| 24 | B4 | BLUE data signal | I | |
| 25 | B5 | BLUE data signal (MSB) | I | |
| 26 | GND | GND | - | |
| 27 | ENAB | Signal to settle the horizontal display position (positive) | I | 1) |
| 28 | V _{DD} | 3.3V power supply | - | |
| 29 | V _{DD} | 3.3V power supply | - | |
| 30 | R/L | Horizontal display mode select signal L : Normal , H : Left / Right reverse mode | I | 2) |
| 31 | U/D | Vertical display mode select signal H : Normal , L : Up / Down reverse mode | I | 2) |
| 32 | NC | No connect | I | |
| 33 | GND | GND | - | |

LCD connector : IMSA-9632S-33Z02-GF1 (IRISO)
Recommended matching FFC or FPC : 0.5mm pitch

- 1) The horizontal display start timing is settled in accordance with a rising timing of ENAB signal.
In case ENAB is fixed "Low", the horizontal start timing is determined.
Don't keep ENAB "High" during operation.

2)



R/L = L
U/D = H



R/L = H
U/D = H



R/L = L
U/D = L

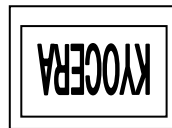

R/L = H
U/D = L

7-2. CFL

| No. | Symbol | Description |
|-----|--------|-----------------------------------|
| 1 | Hot | Inverter output high voltage side |
| 2 | NC | No connect |
| 3 | Cold | Inverter output low voltage side |

LCD side connector : BHR-03VS-1 (JST)

Recommended matching connector

: SM02(8.0)B-BHS-1 (JST)

: SM02(8.0)B-BHS-1-TB(LF)(SN) (JST)···(RoHS Compliant)

7-3. Touch panel

| No. | Symbol | Description |
|-----|--------|------------------|
| 1 | yU | y-Upper terminal |
| 2 | xL | x-Left terminal |
| 3 | yL | y-Lower terminal |
| 4 | xR | x-Right terminal |

Touch panel side connector : 1.25mm pitch

Recommended matching connector : 04FFS-SP-GB-TF(LF)(SN) (JST)

: 00-8370-049-000-888+ (ELCO)

8. Input timing characteristics

8-1. Timing characteristics

| Item | | Symbol | Min | Typ | Max | Unit | Note |
|--------------------------------------|-------------|--------|-------|-------|--------|---------|------|
| Clock | Frequency | 1/Tc | 22.66 | 25.18 | 27.69 | MHz | |
| | Duty ratio | Tch/Tc | 40 | 50 | 60 | % | |
| Data | Set up time | Tds | 5 | — | — | ns | |
| | Hold time | Tdh | 10 | — | — | ns | |
| Horizontal sync. signal | Cycle | TH | 30.0 | 31.8 | — | μs | |
| | | | 770 | 800 | 850 | clock | |
| | Pulse width | THp | 2 | 96 | 200 | clock | |
| Vertical sync. signal | Cycle | TV | 515 | 525 | 560 | line | |
| | Pulse width | TVp | 2 | — | 34 | line | |
| Horizontal display period | | THd | 640 | | | clock | |
| Hsync,-Clock phase difference | | THc | 10 | — | Tc-10 | ns | |
| Hsync-Vsync. phase difference | | TVh | 2Tc | — | TH-THp | ns | |
| Vertical sync. signal start position | | TVs | 34 | | | line | |
| Vertical display period | | TVd | 480 | | | line | |

1) In case of lower frequency, the deterioration of the display quality, flicker etc., may occur.

8-2. Horizontal display position

| Item | | Symbol | Min | Typ | Max | Unit | Note |
|--|-------------|--------|-----|-----|-------|-------|------|
| Enable signal | Set up time | Tes | 5 | — | Tc-10 | ns | |
| | Pulse width | Tep | 2 | 640 | TH-10 | clock | |
| H _{SYNC} – Enable signal phase difference | | The | 44 | — | 104 | clock | |

1) When ENAB is fixed at "Low", the display starts from the data of C104(clock) as shown in 8-5.

2) The horizontal display position is determined by ENAB signal.

8-3. Vertical display position

1) The vertical display position (TVs) is 34th line.

2) ENAB signal is independent of vertical display position.

8-4. Input Data Signals and Display position on the screen

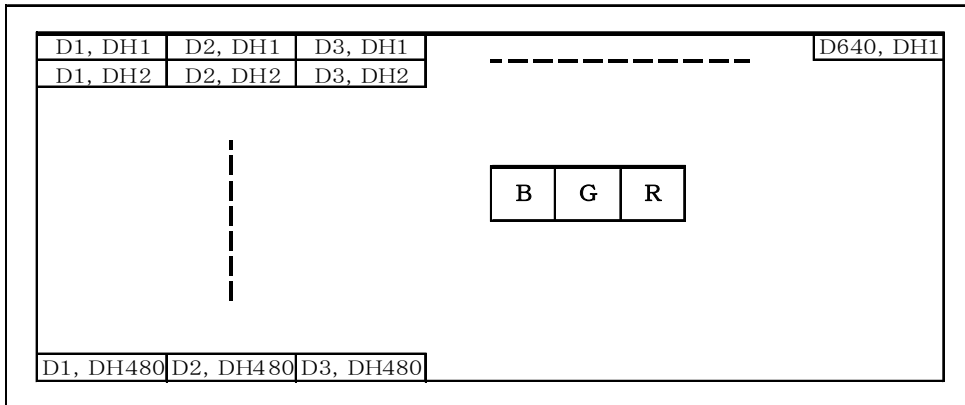

8-5. Input timing characteristics

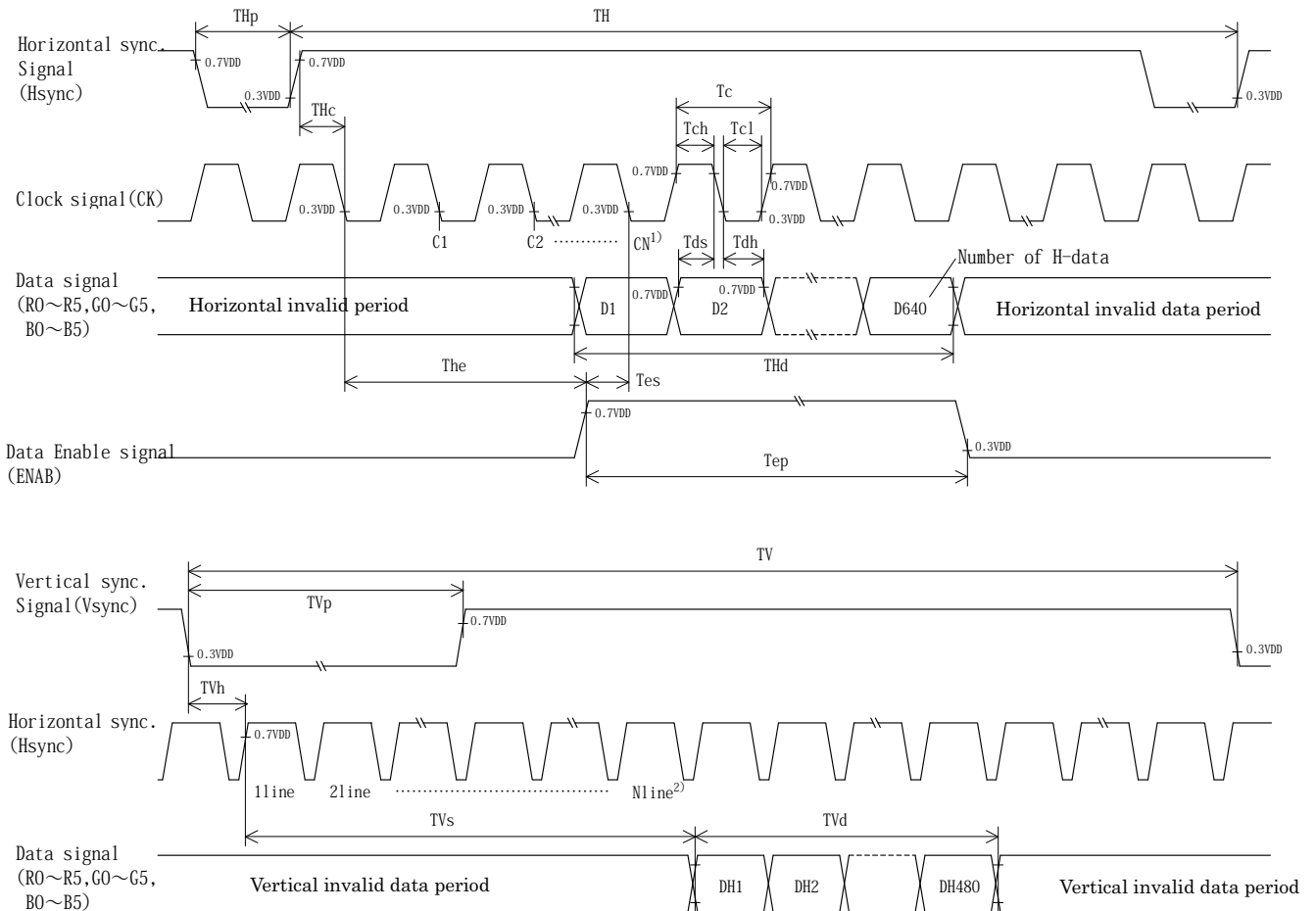

1) When ENAB is fixed at "Low", the display starts from the data of C104(Clock).

2) The vertical display position(TVs) is fixed at 34th line.

9. Backlight characteristics

CFL ratings

Temp.=25°C

| Item | Symbol | Min. | Typ. | Max. | Unit | Note |
|-------------------------------|--------|--------|--------|-------|-------|-------------|
| Starting discharge voltage 1) | VS | - | - | 1,660 | Vrms | -10°C |
| | | - | - | 1,035 | Vrms | 25°C |
| Discharge tube current 2) | IL | 3.0 | 5.0 | 6.0 | mArms | - |
| Discharge tube voltage | VL | - | 685 | - | Vrms | IL=5.0mArms |
| Operating life time 3) | T | 50,000 | 75,000 | - | h | IL=5.0mArms |
| Operating frequency | F | 30 | - | 100 | kHz | - |

- 1) The non-load output voltage (VS) of the inverter should be at least 1.3 times the maximum VS at low temperatures to provide enough margins to assure that the CFL will start, because actual VS may increase due to leakage current from the CFL cables. (Reference value: 2,160 Vrms Min.)
- 2) We recommend that you should set the discharging tube current lower than the typical value to prevent the accumulated heat of the CFL tube from deteriorating the performance of the LCD.
- 3) Defined as when the luminance or quantity of light has decreased to 50% of the initial value. The average life of a CFL will decrease when the LCD is operating at lower temperatures.
- 4) The driving frequency of the CFL may interfere with the horizontal synchronous signal, leaving interference stripes on the display. So please evaluate LCD beforehand.
To avoid interference stripes, we recommend to separate as far as possible the CFL frequency from the horizontal synchronous signal and its high harmonic frequency.
- 5) There may be cases where interface noise on LCD PCB, generated by high-voltage products such as inverters, may leave stripes on the display. Please be careful when designing a mold to take into consideration that the inverter shall be located as far as possible from PCB. Shield protection may be effective.
- 6) Prolonged storage in darkness and/or at low temperature may slow the ignition and rise to full brightness of the CFL. Please use an inverter designed to provide sufficient starting voltage for more than 1 second. Also a decreased starting discharge voltage or shortened ignition time may not turn on the CFL lamp.

10. Design guidance for analog touch panel

10-1 Electrical (In customer's design, please remember the following considerations.)

- 1) Do not use the current regulated circuit.
- 2) Keep the current limit with top and bottom layer.
(Please refer to "Electrical absolute maximum ratings" for details.)
- 3) Analog touch panel can not sense two points touching separately.
- 4) A contact resistance is appeared at the touch point between top and bottom layer.
After this resistance has stable read of the touch panel position data.
- 5) Because noise of inverter or peripheral circuits may interfere signal of touch panel itself it is necessary to design carefully in advance to avoid these noise problem.

10-2 Software

- 1) Do the "User Calibration".
- 2) "User Calibration" may be needed with long term using.
Include "User Calibration" menu in your software.
- 3) When drawing a line with a stylus, there may be a slight discontinuity when the stylus passes over a spacer-dot. If necessary, please provide a compensation feature within your software.

10-3. Mounting on display and housing bezel

- 1) Do not use an adhesive tape to bond it on the front of touch panel and hang it to the housing bezel.
- 2) This touch panel has an airtight but not watertight structure. Please not to use it for the applications requiring watertight or under the environments occurred condensation.
If it is expected to be exposed to the environments that vapor, moisture or other liquids may seep inside a bezel, please be sure to take some measurements for drip-proof or waterproof by using sealing materials on the bezel.

11. Lot number identification

The lot number shall be indicated on the back of the backlight case of each LCD.

TCG057VG1CE-H50 - □□ - □□ - □ MADE IN □□□□□
 ↓ ↓ ↓ ↓ ↓
 1 2 3 4 5

No1. - No5. above indicate
 1. Year code
 2. Month code
 3. Date
 4. Version Number
 5. Country of origin (Japan or China)

| | | | | | | |
|------|------|------|------|------|------|------|
| Year | 2009 | 2010 | 2011 | 2012 | 2013 | 2014 |
| Code | 9 | 0 | 1 | 2 | 3 | 4 |

| | | | | | | |
|-------|------|------|------|------|-----|------|
| Month | Jan. | Feb. | Mar. | Apr. | May | Jun. |
| Code | 1 | 2 | 3 | 4 | 5 | 6 |

| | | | | | | |
|-------|------|------|------|------|------|------|
| Month | Jul. | Aug. | Sep. | Oct. | Nov. | Dec. |
| Code | 7 | 8 | 9 | X | Y | Z |

12. Warranty

12-1. Incoming inspection

Please inspect the LCD within one month after your receipt.

12-2. Production warranty

Kyocera warrants its LCD's for a period of 12 months from the ship date. Kyocera shall, by mutual agreement, replace or re-work defective LCD's that are shown to be Kyocera's responsibility.

13. Precautions for use

13-1. Installation of the LCD

- 1) The LCD has a grounding hole. Please ground the LCD to prevent noise and to stabilize its performance as circumstances demand.

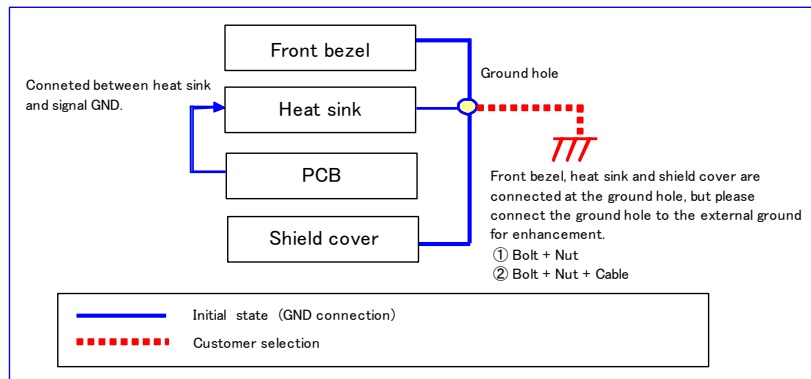

- 2) The LCD shall be installed so that there is no pressure on the LSI chips.
- 3) The LCD shall be installed flat, without twisting or bending.
- 4) Please refer to the following our recommendable value of Clamp-down torque when installing.
Clamp-down torque : $0.32 \pm 0.03 \text{N} \cdot \text{m}$
Please set up 'SPEED-LOW', 'SOFT START-SLOW' when using electric driver.
Recommendable screw JIS tapping screw two types nominal dia.3.0mm installing boss hole depth $3.5 \pm 0.5 \text{mm}$
Please be careful not to use high torque which may damage LCD in installation.
- 5) A transparent protection sheet is attached to the polarizer. Please remove the protection film slowly before use, paying attention to static electricity.

13-2. Static electricity

- 1) Since CMOS ICs are mounted directly onto the LCD glass, protection from static electricity is required.
- 2) Workers should use body grounding. Operator should wear ground straps.

13-3. LCD operation

- 1) The LCD shall be operated within the limits specified. Operation at values outside of these limits may shorten life, and/or harm display images.

13-4. Storage

- 1) The LCD shall be stored within the temperature and humidity limits specified.
Store in a dark area, and protect the LCD from direct sunlight or fluorescent light.
- 2) Always store the LCD so that it is free from external pressure onto it.

13-5. Usage

- 1) **DO NOT** store in a high humidity environment for extended periods. Polarizer degradation bubbles, and/or peeling off of the polarizer may result.
- 2) Do not push or rub the touch panel's surface with hard to sharp objects such as knives, or the touch panel may be scratched.
- 3) When the touch panel is dirty, gently wipe the surface with a soft cloth, sometimes moistened by mild detergent or alcohol. If a hazardous chemical is dropped on the touch panel by mistake, wipe it off right away to prevent human contact.
- 4) Touch panel edges are sharp. Handle the touch panel with enough care to prevent cuts
- 5) Always keep the LCD free from condensation during testing. Condensation may permanently spot or stain the polarizer.
- 6) Do not pull the CFL lead wires and do not bend the root of the wires. Housing should be designed to protect CFL lead wires from external stress.
- 7) Do not disassemble LCD because it will result in damage.
- 8) This Kyocera LCD has been specifically designed for use in general electronic devices, but not for use in a special environment such as usage in an active gas. Hence, when the LCD is supposed to be used in a special environment, evaluate the LCD thoroughly beforehand and do not expose the LCD to chemicals such as an active gas.
- 9) Please do not use solid-base image pattern for long hours because a temporary afterimage may appear. We recommend using screen saver etc. in cases where a solid-base image pattern must be used.
- 10) Liquid crystal may leak when the LCD is broken. Be careful not to let the fluid go into your eyes and mouth. In the case the fluid touches your body; rinse it off right away with water and soap.

14. Reliability test data

| Test item | Test condition | Test time | Judgement |
|--------------------------------|--|-------------------|--|
| High temp. atmosphere | 80°C | 240h | Display function : No defect Display quality : No defect Current consumption : No defect |
| Low temp. atmosphere | -30°C | 240h | Display function : No defect Display quality : No defect Current consumption : No defect |
| High temp. humidity atmosphere | 40°C 90% RH | 240h | Display function : No defect Display quality : No defect Current consumption : No defect |
| Temp. cycle | -30°C 0.5h R.T. 0.5h 80°C 0.5h | 10cycles | Display function : No defect Display quality : No defect Current consumption : No defect |
| High temp. operation | 70°C | 500h | Display function : No defect Display quality : No defect Current consumption : No defect |
| Point Activation life | Polyacetal stylus R4, Hardness 60° Hitting force 2.9N Hitting speed 5 time/s | one million times | Terminal resistance : No defect Insulation resistance : No defect Linearity : No defect Actuation Force : No defect |

- 1) Each test item uses a test LCD only once. The tested LCD is not used in any other tests.
- 2) The LCD is tested in circumstances in which there is no condensation.
- 3) The reliability test is not an out-going inspection.
- 4) The result of the reliability test is for your reference purpose only.
The reliability test is conducted only to examine the LCD's capability.

| No. | Description | Drawn | Checked | Checked | Approved |
|-----|-------------|-------|---------|---------|----------|
| | | | | | |
| | | | | | |
| | | | | | |

| No. | Description | Drawn | Checked | Checked | Approved |
|-----|-------------|-------|---------|---------|----------|
| | | | | | |
| | | | | | |
| | | | | | |

| Name(名称) | Explanation(説明) |
|-------------------------------------|--|
| 1 T.P. | Touch panel (タッチパネル) |
| 2 T.P. Active Area (T.P.アクティブエリア) | Operating area of touch panel (タッチパネルの動作範囲) |
| 3 T.P. Viewing Area (T.P.ビューイングエリア) | Warranty area of touch panel's appearance (タッチパネルの外観(傷・異物等)保証範囲) By giving pressure between the active area and the viewing area of the touch panel, there is a possibility that the touch panel will operate. (タッチパネルのアクティブエリアとタッチパネルビューイングエリア間には荷重をかけた場合は、タッチパネルが動作する可能性があります。) |

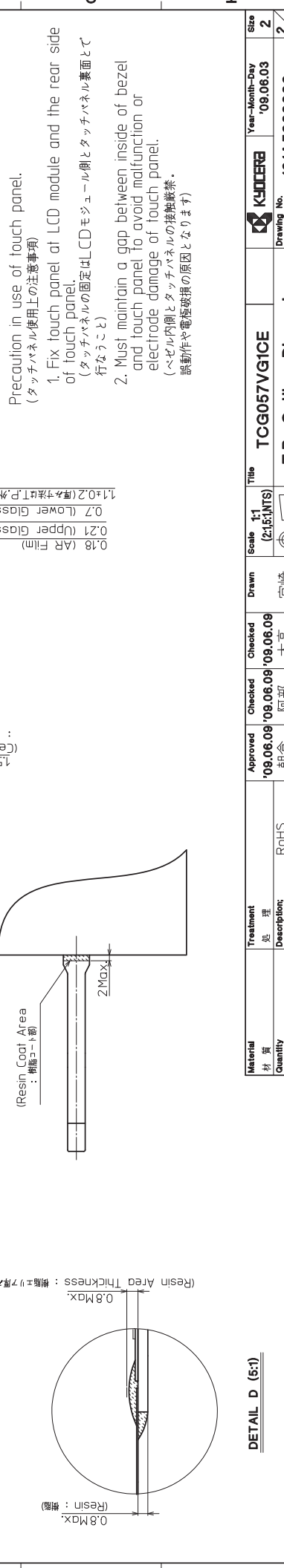
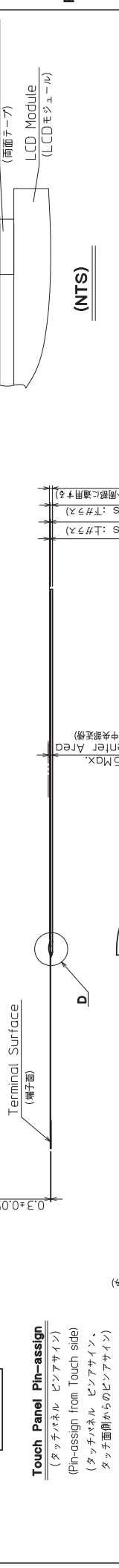
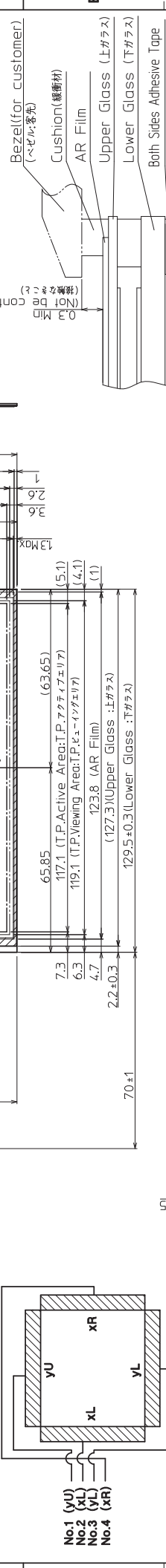
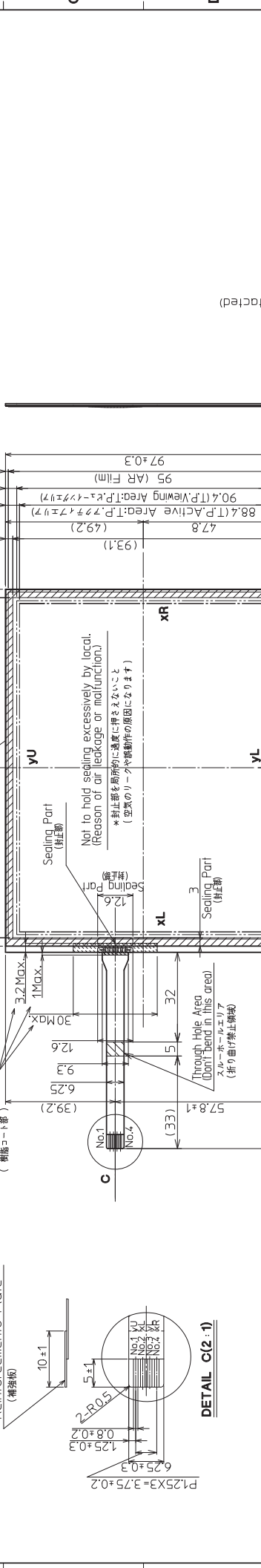

(NTS)

Precaution in use of touch panel.
(タッチパネル使用上の注意事項)

1. Fix touch panel at LCD module and the rear side of touch panel.
(タッチパネルの固定はLCDモジュール側とタッチパネル裏面とで行なうこと)
2. Must maintain a gap between inside of bezel and touch panel to avoid malfunction or electrode damage of touch panel.
(ベゼル内側とタッチパネルの接触防止。誤動作や電極破損の原因となります)

| Material | Treatment | Approved | Checked | Checked | Drawn | Scale | Title | Year-Month-Day | Size |
|----------|--------------|-----------|-----------|-----------|-------|-------------------|-------------------------|----------------|------|
| 材質 | 処理 | '09.06.09 | '08.06.09 | '08.06.08 | 宮崎 | 1:1 (2.1E:NTS) | TCG057VG1CE | '09.06.03 | 2 |
| Quantity | Description: | 朝倉 | 阿部 | 大高 | 宮崎 | | T.P. Outline Dimensions | 121A5089800 | 2 |
| 製作数 | 備考 | 朝倉 | 阿部 | 大高 | 宮崎 | | | 121A5089800 | 2 |

| | |
|----------|-----------------------|
| Spec No. | TQ3C-8EAF0-E2DEU14-00 |
| Date | May 15, 2009 |

KYOCERA INSPECTION STANDARD

TYPE : TCG057VG1CE-H50

KYOCERA CORPORATION
KAGOSHIMA HAYATO PLANT
LCD DIVISION

| Original Issue Date | Designed by : Engineering dept. | | | Confirmed by : QA dept. | |
|---------------------|---------------------------------|---------------------|--------------------|-------------------------|----------------|
| | Prepared | Checked | Approved | Checked | Approved |
| May 15, 2009 | Y IKEDA | <i>Y. Yamaguchi</i> | <i>W. Tokumaru</i> | <i>J. Sakaguchi</i> | <i>H. Aoki</i> |

| | | |
|-----------------------------------|-----------------------------|-----------|
| Spec No. TQ3C-8EAF0-E2DEU14-00 | Part No. TCG057VG1CE-H50 | Page - |
|-----------------------------------|-----------------------------|-----------|

Revision record

| Date | | Designed by : Engineering dept. | | | Confirmed by : QA dept. | |
|---------|------|---------------------------------|--------------|----------|-------------------------|----------|
| | | Prepared | Checked | Approved | Checked | Approved |
| | | | | | | |
| Rev.No. | Date | Page | Descriptions | | | |
| | | | | | | |

Visuals specification

1) Note

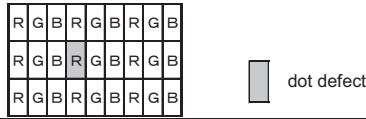
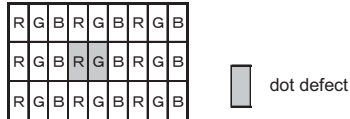
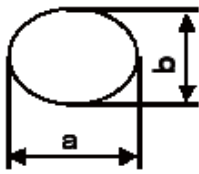
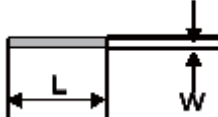
| | | Note |
|-------------------------------|---|--|
| General | <p>1. Customer identified anomalies not defined within this inspection standard shall be reviewed by Kyocera, and an additional standard shall be determined by mutual consent.</p> <p>2. This inspection standard about the image quality shall be applied to any defect within the active area and shall not be applicable to outside of the area.</p> <p>3. Inspection conditions</p> <p>Luminance : 500 Lux min.</p> <p>Inspection distance : 300 mm.</p> <p>Temperature : 25 ± 5°C</p> <p>Direction : Directly above</p> | |
| Definition of inspection item | Dot defect | <p>Bright dot defect</p> <p>The dot is constantly “on” when power applied to the LCD, even when all “Black” data sent to the screen. Inspection tool: 5% Transparency neutral density filter. Count dot: If the dot is visible through the filter. Don't count dot: If the dot is not visible through the filter.</p>  |
| | | <p>Black dot defect</p> <p>The dot is constantly “off” when power applied to the LCD, even when all “White” data sent to the screen.</p> |
| | | <p>Adjacent dot</p> <p>Adjacent dot defect is defined as two or more bright dot defects or black dot defects.</p>  |
| | External inspection | <p>Bubble, Scratch, Foreign particle (Polarizer, Cell, Backlight)</p> <p>Visible operating (all pixels “Black” or “White”) and non operating.</p> |
| | | <p>Appearance inspection</p> <p>Does not satisfy the value at the spec.</p> |
| | Others | <p>CFL wire</p> <p>Damaged to the CFL wires connector, pin, functional failure or appearance failure.</p> |
| Definition of size | <p>Definition of circle size</p>  <p>$d = (a + b) / 2$</p> <p>Definition of linear size</p>  | |

2) Standard

| Classification | | Inspection item | Judgement standard | | | | | | | | | | | | | | | | |
|--|--|--|--|-----------------------|-------------------|-------------------|-------------------|--------------------|--------------------|---------------------|--------------------|--------------------|--------------------|-----------|-----------|-----------|-----------|---|-------------------------------|
| Defect (in LCD glass) | Dot defect | Bright dot defect | Acceptable number : 4 Bright dot spacing : 5 mm or more | | | | | | | | | | | | | | | | |
| | | Black dot defect | Acceptable number : 5 Black dot spacing : 5 mm or more | | | | | | | | | | | | | | | | |
| | | 2 dot join | Bright dot defect | Acceptable number : 2 | | | | | | | | | | | | | | | |
| | | | Black dot defect | Acceptable number : 3 | | | | | | | | | | | | | | | |
| | | 3 or more dots join | Acceptable number : 0 | | | | | | | | | | | | | | | | |
| | | Total dot defects | Acceptable number : 5 Max | | | | | | | | | | | | | | | | |
| | Others | White dot, Dark dot (Circle) | <table border="1"> <thead> <tr> <th>Size (mm)</th> <th>Acceptable number</th> </tr> </thead> <tbody> <tr> <td>$d \leq 0.2$</td> <td>(Neglected)</td> </tr> <tr> <td>$0.2 < d \leq 0.4$</td> <td>5</td> </tr> <tr> <td>$0.4 < d \leq 0.5$</td> <td>3</td> </tr> <tr> <td>$0.5 < d$</td> <td>0</td> </tr> </tbody> </table> | | | Size (mm) | Acceptable number | $d \leq 0.2$ | (Neglected) | $0.2 < d \leq 0.4$ | 5 | $0.4 < d \leq 0.5$ | 3 | $0.5 < d$ | 0 | | | | |
| Size (mm) | Acceptable number | | | | | | | | | | | | | | | | | | |
| $d \leq 0.2$ | (Neglected) | | | | | | | | | | | | | | | | | | |
| $0.2 < d \leq 0.4$ | 5 | | | | | | | | | | | | | | | | | | |
| $0.4 < d \leq 0.5$ | 3 | | | | | | | | | | | | | | | | | | |
| $0.5 < d$ | 0 | | | | | | | | | | | | | | | | | | |
| External inspection (Defect on Polarizer or between Polarizer and LCD glass) | Polarizer (Scratch) | <table border="1"> <thead> <tr> <th>Width (mm)</th> <th>Length (mm)</th> <th>Acceptable number</th> </tr> </thead> <tbody> <tr> <td>$W \leq 0.1$</td> <td>—</td> <td>(Neglected)</td> </tr> <tr> <td rowspan="2">$0.1 < W \leq 0.3$</td> <td>$L \leq 5.0$</td> <td>(Neglected)</td> </tr> <tr> <td>$5.0 < L$</td> <td>0</td> </tr> <tr> <td>$0.3 < W$</td> <td>—</td> <td>0</td> </tr> </tbody> </table> | | | Width (mm) | Length (mm) | Acceptable number | $W \leq 0.1$ | — | (Neglected) | $0.1 < W \leq 0.3$ | $L \leq 5.0$ | (Neglected) | $5.0 < L$ | 0 | $0.3 < W$ | — | 0 | |
| | | Width (mm) | Length (mm) | Acceptable number | | | | | | | | | | | | | | | |
| | | $W \leq 0.1$ | — | (Neglected) | | | | | | | | | | | | | | | |
| | | $0.1 < W \leq 0.3$ | $L \leq 5.0$ | (Neglected) | | | | | | | | | | | | | | | |
| | $5.0 < L$ | | 0 | | | | | | | | | | | | | | | | |
| | $0.3 < W$ | — | 0 | | | | | | | | | | | | | | | | |
| | Polarizer (Bubble) | <table border="1"> <thead> <tr> <th>Size (mm)</th> <th>Acceptable number</th> </tr> </thead> <tbody> <tr> <td>$d \leq 0.2$</td> <td>(Neglected)</td> </tr> <tr> <td>$0.2 < d \leq 0.3$</td> <td>5</td> </tr> <tr> <td>$0.3 < d \leq 0.5$</td> <td>3</td> </tr> <tr> <td>$0.5 < d$</td> <td>0</td> </tr> </tbody> </table> | | | Size (mm) | Acceptable number | $d \leq 0.2$ | (Neglected) | $0.2 < d \leq 0.3$ | 5 | $0.3 < d \leq 0.5$ | 3 | $0.5 < d$ | 0 | | | | | |
| | | Size (mm) | Acceptable number | | | | | | | | | | | | | | | | |
| | | $d \leq 0.2$ | (Neglected) | | | | | | | | | | | | | | | | |
| | | $0.2 < d \leq 0.3$ | 5 | | | | | | | | | | | | | | | | |
| | $0.3 < d \leq 0.5$ | 3 | | | | | | | | | | | | | | | | | |
| | $0.5 < d$ | 0 | | | | | | | | | | | | | | | | | |
| Foreign particle (Circular shape) | <table border="1"> <thead> <tr> <th>Size (mm)</th> <th>Acceptable number</th> </tr> </thead> <tbody> <tr> <td>$d \leq 0.2$</td> <td>(Neglected)</td> </tr> <tr> <td>$0.2 < d \leq 0.4$</td> <td>5</td> </tr> <tr> <td>$0.4 < d \leq 0.5$</td> <td>3</td> </tr> <tr> <td>$0.5 < d$</td> <td>0</td> </tr> </tbody> </table> | | | Size (mm) | Acceptable number | $d \leq 0.2$ | (Neglected) | $0.2 < d \leq 0.4$ | 5 | $0.4 < d \leq 0.5$ | 3 | $0.5 < d$ | 0 | | | | | | |
| | Size (mm) | Acceptable number | | | | | | | | | | | | | | | | | |
| | $d \leq 0.2$ | (Neglected) | | | | | | | | | | | | | | | | | |
| | $0.2 < d \leq 0.4$ | 5 | | | | | | | | | | | | | | | | | |
| $0.4 < d \leq 0.5$ | 3 | | | | | | | | | | | | | | | | | | |
| $0.5 < d$ | 0 | | | | | | | | | | | | | | | | | | |
| Foreign particle (Linear shape) Scratch | <table border="1"> <thead> <tr> <th>Width (mm)</th> <th>Length (mm)</th> <th>Acceptable number</th> </tr> </thead> <tbody> <tr> <td>$W \leq 0.03$</td> <td>—</td> <td>(Neglected)</td> </tr> <tr> <td rowspan="3">$0.03 < W \leq 0.1$</td> <td>$L \leq 2.0$</td> <td>(Neglected)</td> </tr> <tr> <td>$2.0 < L \leq 4.0$</td> <td>3</td> </tr> <tr> <td>$4.0 < L$</td> <td>0</td> </tr> <tr> <td>$0.1 < W$</td> <td>—</td> <td>(According to circular shape)</td> </tr> </tbody> </table> | | | Width (mm) | Length (mm) | Acceptable number | $W \leq 0.03$ | — | (Neglected) | $0.03 < W \leq 0.1$ | $L \leq 2.0$ | (Neglected) | $2.0 < L \leq 4.0$ | 3 | $4.0 < L$ | 0 | $0.1 < W$ | — | (According to circular shape) |
| | Width (mm) | Length (mm) | Acceptable number | | | | | | | | | | | | | | | | |
| | $W \leq 0.03$ | — | (Neglected) | | | | | | | | | | | | | | | | |
| | $0.03 < W \leq 0.1$ | $L \leq 2.0$ | (Neglected) | | | | | | | | | | | | | | | | |
| | | $2.0 < L \leq 4.0$ | 3 | | | | | | | | | | | | | | | | |
| $4.0 < L$ | | 0 | | | | | | | | | | | | | | | | | |
| $0.1 < W$ | — | (According to circular shape) | | | | | | | | | | | | | | | | | |

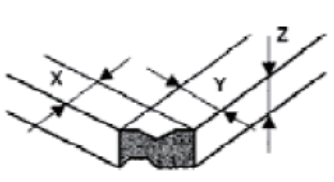
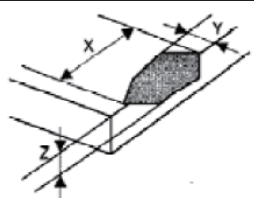
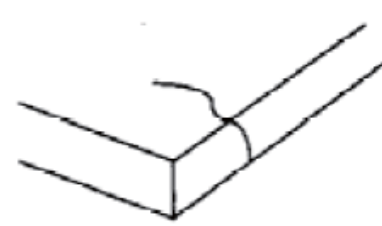
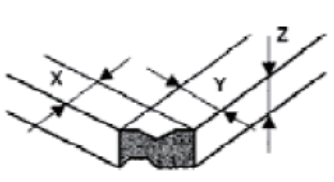
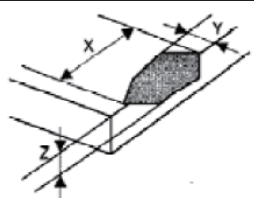
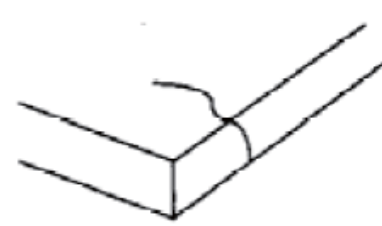
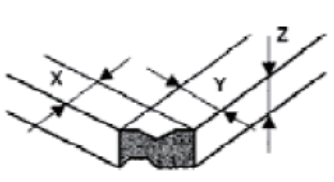
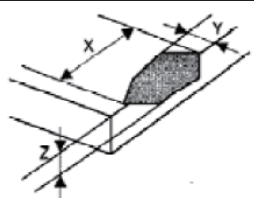
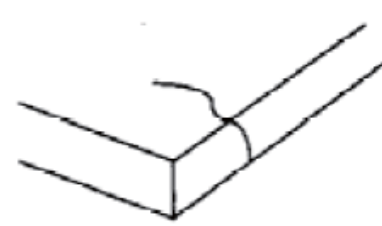
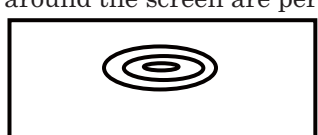
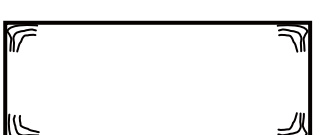
| Inspection item | Judgement standard | | | | | | | | | | | | | | | | | | | | | | | | | | | | | | | |
|---|---|----------------------|--------------------------------|-------------------|-------------------|---|---------------|--------------|------------|----------------------|------------------------------------|---|----------------------|-------------|--------------------------------|---------------------|-------------------|--|------------------------|---------------|-----------|-----------|---------------------|------------|--------------------------------|--------------------------|--------------|--|-----------|--------------------|--|--------------------------------|
| Scratch, Foreign particle (Touch screen portion) | <p>(W = Width, L = Length, D = Diameter = (major axis + minor axis) / 2)</p> <table border="1"> <thead> <tr> <th>Item</th> <th>Width(mm)</th> <th>Length(mm)</th> <th>Acceptable number</th> </tr> </thead> <tbody> <tr> <td rowspan="4">Scratch</td> <td>$d \leq 0.03$</td> <td>$L \leq 20$</td> <td>Neglected</td> </tr> <tr> <td>$0.03 < d \leq 0.05$</td> <td>$L \leq 10$</td> <td>2pcs within $\phi 20\text{mm}$</td> </tr> <tr> <td>$0.05 < d \leq 0.08$</td> <td>$L \leq 6$</td> <td>2pcs within $\phi 20\text{mm}$</td> </tr> <tr> <td>$0.08 < d \leq 0.1$</td> <td>$L \leq 4$</td> <td>1pcs within $\phi 30\text{mm}$</td> </tr> <tr> <td rowspan="2">Foreign (line like)</td> <td>$W \leq 0.05$</td> <td>Neglected</td> <td>Neglected</td> </tr> <tr> <td>$0.05 < W \leq 0.1$</td> <td>$L \leq 5$</td> <td>2pcs within $\phi 30\text{mm}$</td> </tr> <tr> <td rowspan="2">Foreign (circle like)</td> <td colspan="2">$D \leq 0.2$</td> <td>Neglected</td> </tr> <tr> <td colspan="2">$0.2 < D \leq 0.3$</td> <td>2pcs within $\phi 30\text{mm}$</td> </tr> </tbody> </table> <p>Above are applied to the visible area. Unless there are foreign particle and damage affected seriously to the electrical performance out of the active area, we approve of this product.</p> | Item | Width(mm) | Length(mm) | Acceptable number | Scratch | $d \leq 0.03$ | $L \leq 20$ | Neglected | $0.03 < d \leq 0.05$ | $L \leq 10$ | 2pcs within $\phi 20\text{mm}$ | $0.05 < d \leq 0.08$ | $L \leq 6$ | 2pcs within $\phi 20\text{mm}$ | $0.08 < d \leq 0.1$ | $L \leq 4$ | 1pcs within $\phi 30\text{mm}$ | Foreign (line like) | $W \leq 0.05$ | Neglected | Neglected | $0.05 < W \leq 0.1$ | $L \leq 5$ | 2pcs within $\phi 30\text{mm}$ | Foreign (circle like) | $D \leq 0.2$ | | Neglected | $0.2 < D \leq 0.3$ | | 2pcs within $\phi 30\text{mm}$ |
| Item | Width(mm) | Length(mm) | Acceptable number | | | | | | | | | | | | | | | | | | | | | | | | | | | | | |
| Scratch | $d \leq 0.03$ | $L \leq 20$ | Neglected | | | | | | | | | | | | | | | | | | | | | | | | | | | | | |
| | $0.03 < d \leq 0.05$ | $L \leq 10$ | 2pcs within $\phi 20\text{mm}$ | | | | | | | | | | | | | | | | | | | | | | | | | | | | | |
| | $0.05 < d \leq 0.08$ | $L \leq 6$ | 2pcs within $\phi 20\text{mm}$ | | | | | | | | | | | | | | | | | | | | | | | | | | | | | |
| | $0.08 < d \leq 0.1$ | $L \leq 4$ | 1pcs within $\phi 30\text{mm}$ | | | | | | | | | | | | | | | | | | | | | | | | | | | | | |
| Foreign (line like) | $W \leq 0.05$ | Neglected | Neglected | | | | | | | | | | | | | | | | | | | | | | | | | | | | | |
| | $0.05 < W \leq 0.1$ | $L \leq 5$ | 2pcs within $\phi 30\text{mm}$ | | | | | | | | | | | | | | | | | | | | | | | | | | | | | |
| Foreign (circle like) | $D \leq 0.2$ | | Neglected | | | | | | | | | | | | | | | | | | | | | | | | | | | | | |
| | $0.2 < D \leq 0.3$ | | 2pcs within $\phi 30\text{mm}$ | | | | | | | | | | | | | | | | | | | | | | | | | | | | | |
| Glass crack (Touch screen portion) | <table border="1"> <thead> <tr> <th>Item</th> <th>Size (mm)</th> <th>Acceptable number</th> </tr> </thead> <tbody> <tr> <td rowspan="3">Corner crack</td> <td rowspan="3">  </td> <td>X ≤ 3</td> <td rowspan="3">2 pcs /panel</td> </tr> <tr> <td>Y ≤ 3</td> </tr> <tr> <td>Z $< t$</td> </tr> <tr> <td rowspan="3">Crack in other area than in corner</td> <td rowspan="3">  </td> <td>X ≤ 5</td> <td rowspan="3">2 pcs /side</td> </tr> <tr> <td>Y ≤ 1.5</td> </tr> <tr> <td>Z $< t$</td> </tr> <tr> <td>Progressive crack</td> <td>  </td> <td>0 pcs (NG even 1pcs)</td> </tr> </tbody> </table> <p>Above are applied to the visible area. Unless there are foreign particle and damage affected seriously to the electrical performance out of the active area, we approve of this product.</p> | Item | Size (mm) | Acceptable number | Corner crack |  | X ≤ 3 | 2 pcs /panel | Y ≤ 3 | Z $< t$ | Crack in other area than in corner |  | X ≤ 5 | 2 pcs /side | Y ≤ 1.5 | Z $< t$ | Progressive crack |  | 0 pcs (NG even 1pcs) | | | | | | | | | | | | | |
| Item | Size (mm) | Acceptable number | | | | | | | | | | | | | | | | | | | | | | | | | | | | | | |
| Corner crack |  | X ≤ 3 | 2 pcs /panel | | | | | | | | | | | | | | | | | | | | | | | | | | | | | |
| | | Y ≤ 3 | | | | | | | | | | | | | | | | | | | | | | | | | | | | | | |
| | | Z $< t$ | | | | | | | | | | | | | | | | | | | | | | | | | | | | | | |
| Crack in other area than in corner |  | X ≤ 5 | 2 pcs /side | | | | | | | | | | | | | | | | | | | | | | | | | | | | | |
| | | Y ≤ 1.5 | | | | | | | | | | | | | | | | | | | | | | | | | | | | | | |
| | | Z $< t$ | | | | | | | | | | | | | | | | | | | | | | | | | | | | | | |
| Progressive crack |  | 0 pcs (NG even 1pcs) | | | | | | | | | | | | | | | | | | | | | | | | | | | | | | |
| Newton's ring | <p>All Newton Rings in the center of the screen must be rejected. Border around the screen are permitted.</p> <div style="display: flex; justify-content: space-around; align-items: center;"> <div style="text-align: center;">  <p>NG</p> </div> <div style="text-align: center;">  <p>OK</p> </div> </div> | | | | | | | | | | | | | | | | | | | | | | | | | | | | | | | |